





## CONTENTS

4	SAFETY INFORMATION
6	PRODUCT DESCRIPTION
7	ACCESSORIES
8	CONTROL PANEL
9	BEFORE FIRST USE
9	PROGRAMMES
10	USING THE APPLIANCE
13	HINTS AND TIPS
14	CARE AND CLEANING
19	TROUBLESHOOTING
21	TECHNICAL INFORMATION
22	INSTALLATION

## ENVIRONMENT CONCERNS

Recycle the materials with the symbol . Put the packaging in applicable containers to recycle it.



Help protect the environment and human health and to recycle waste of electrical and electronic appliances. Do not dispose appliances marked with the symbol  with the household waste. Return the product to your local recycling facility or contact your municipal office.

## VISIT OUR WEBSITE FOR:

- Products
- Brochures
- User manuals
- Trouble shooter
- Service information

[www.aeg.com](http://www.aeg.com)

## LEGEND

-  Warning - Important Safety information.
-  General information and tips
-  Environmental information

Subject to change without notice.

## FOR PERFECT RESULTS

Thank you for choosing this AEG product. We have created it to give you impeccable performance for many years, with innovative technologies that help make life simpler – features you might not find on ordinary appliances. Please spend a few minutes reading to get the very best from it.

## ACCESSORIES AND CONSUMABLES

In the AEG webshop, you'll find everything you need to keep all your AEG appliances looking spotless and working perfectly. Along with a wide range of accessories designed and built to the high quality standards you would expect, from specialist cookware to cutlery baskets, from bottle holders to delicate laundry bags...



Visit the webshop at:  
[www.aeg.com/shop](http://www.aeg.com/shop)

## CUSTOMER CARE AND SERVICE

We recommend the use of original spare parts.

When contacting Service, ensure that you have the following data available. The information can be found on the rating plate.

Model \_\_\_\_\_

PNC \_\_\_\_\_

Serial Number \_\_\_\_\_



## SAFETY INFORMATION

**In the interest of your safety and to ensure the correct use, before installing and first using the appliance, read this user manual carefully, including its hints and warnings. To avoid unnecessary mistakes and accidents, it is important to ensure that all people using the appliance are thoroughly familiar with its operation and safety features. Save these instructions and make sure that they remain with the appliance if it is moved or sold, so that everyone using it through its life will be properly informed on appliance use and safety.**



- Read the instruction manual before the appliance use.

### GENERAL SAFETY

- It is dangerous to alter the specifications or attempt to modify this product in any way.
- This appliance is not intended for use by persons (including children) with reduced physical and sensory conditions or lack of experience and knowledge, unless they have been given supervision or instruction concerning use of the appliance by a person responsible for their safety.
- Make sure that small children and pets do not climb inside the drum. To avoid this, please check into the drum before using.
- Any objects such as coins, safety pins, nails, screws, stones or any other hard, sharp material can cause extensive damage and must not be placed into the machine.
- Items such as foam rubber (latex foam), shower caps, waterproof textiles (if there is no special drying programme), rubber backed articles and clothes or pillows fitted with foam rubber pads must not be dried in the tumble dryer.
- Make sure that there is access to the mains plug after the installation.
- Always unplug the appliance after use, cleaning and maintenance.
- Under no circumstances should you attempt to repair the machine yourself. Repairs carried out by inexperienced persons may cause injury or serious malfunctioning. Contact your local Service Centre. Always insist on genuine spare parts.
- Items that have been soiled with substances such as cooking oil acetone, petrol, kerosene, spot removers, turpentine, waxes and wax removers should be washed in hot water with an extra amount of detergent before being dried in the tumble dryer.
- **Danger of explosion:** Never tumble dry items that have been in contact with inflammable solvents (petrol, methylated spirits, dry cleaning fluid and the like). As these substances are volatile, they could cause an explosion. Only tumble dry items washed with water.
- **Risk of fire:** items that have been spotted or soaked with vegetable or cooking oil constitute a fire hazard and should not be placed in the tumble dryer.
- If you have washed your laundry with stain remover you must execute an extra rinse cycle before loading your tumble dryer.
- Please make sure that no gas lighters or matches have accidentally been left in pockets of garments in case they are loaded into appliance
- The condensed water is not applicable to drink or to prepare food. It can cause health problems to people and pets.
- Do not seat or lean on the load door. The appliance can tilt.



### WARNING!

- **Risk of fire! To prevent from the risk of self combustion do not stop a tumble dryer before the end of the drying cycle unless all items are quickly removed and spread out so that the heat is dissipated.**
- **Lint must not be allowed to accumulate around the tumble dryer.**

- **Risk of electric shock!** Do not spray down the appliance with jets of water.
- The final part of a tumble dryer cycle occurs without heat (cool down cycle)

to ensure that the items are left at a temperature that ensures that items will not be damaged.

- The tumble dryer is not to be used if industrial chemicals have been used for cleaning.
- Ensure you have good ventilation in the installation room to avoid the back flow of gases into the room from appliances burning other fuels, including open fires.

## INSTALLATION

- This appliance is heavy. Be careful when you move the appliance.
- When unpacking the appliance, check that it is not damaged. If in doubt, do not use it and contact the Service Centre.
- All packaging must be removed before use. Dangerous damage can occur to the product and to property if this is not adhered to. See relevant section in the user manual.
- Each electrical work necessary to install this appliance must be done by a qualified electrician or competent person.
- The rear surface of the appliance must be put against the wall
- If the appliance is installed on the carpet or equivalent, adjust the feet. Air must flow freely below the appliance.
- After the appliance installation, check that it is not squeeze or stay on the electrical supply cable.
- If the tumble dryer is put on top of a washing machine, it is mandatory to use the stacking kit (optional accessory - see chapter: "ACCESSORIES").

## USE

- This appliance is for domestic use only. It must not be used for other functions .
- Only dry fabrics which are applicable to dry in the tumble dryer. Follow the instructions on each piece of clothing label.
- Do not dry not washed items in the tumble dryer.
- Do not put more load than recommended. Obey the maximum load volume. See the related chapter in the user manual.

- Clothes which are dripping wet must not be put in the tumble dryer.
- Garments which have been in contact with volatile petroleum products should not be machine dried. If volatile cleaning fluids are used, care should be taken to ensure that the fluid is removed from the garment before placing in the appliance.
- Do not use the tumble dryer if the power supply cable, the control panel, the working surface or the base are damaged so that the inside of the tumble dryer is accessible.
- Fabric softener or equivalent products must be used as specified by the fabric softener manufacturer.
- Risk of fire! Do not dry the damaged items which contain padding or fillings (pillows, jackets, duvets, etc.). The padding or fillings can get out and cause the fire.

## CHILD SAFETY

- This machine is not intended for use by young children or infirm persons without supervision.
- Children often do not recognise the hazards associated with electrical appliances. Children should be supervised to ensure that they do not play with the appliance.



### WARNING!

- Danger of suffocation! The packaging components (e.g. plastic film, polystyrene) can be dangerous to children - Keep them out of children's reach.
- Keep all detergents in a safe place out of children's reach.
- Make sure that children or pets do not climb inside the drum.

## DISCARD THE APPLIANCE

- Disconnect the mains plug from the mains socket.
- Cut off the mains cable and discard it.
- Discard the door catch. This prevents children or pets to be closed in the appliance. There is a risk of suffocation.

## PRODUCT DESCRIPTION

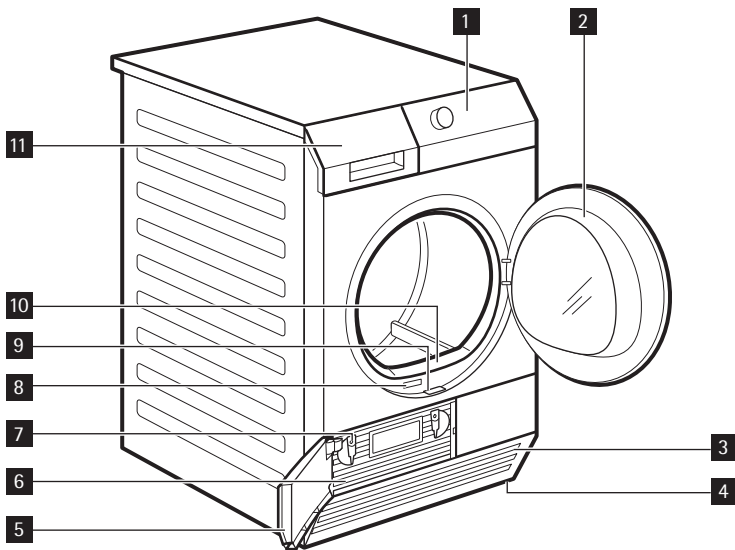

- 1** Control panel
- 2** Load door (reversible)
- 3** Airflow slots
- 4** Adjustable feet
- 5** Condenser door
- 6** Condenser cover
- 7** Lock knobs
- 8** Rating plate
- 9** Sliding button to open the condenser door
- 10** Filter
- 11** Water container

## ACCESSORIES

### STACKING KIT

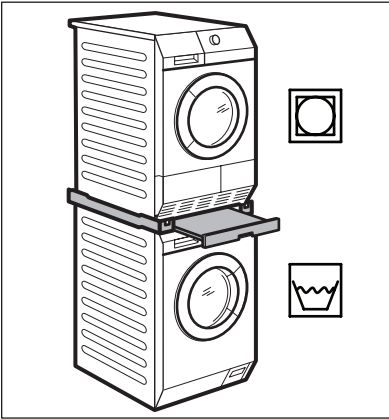

Product name: SKP11  
 Available from your authorized dealer.  
 Stacking kit can be used only with the  
 washing machines specified in the leaflet.  
 See leaflet attached.  
 Read carefully the instructions supplied  
 with the kit.

### DRAINING KIT

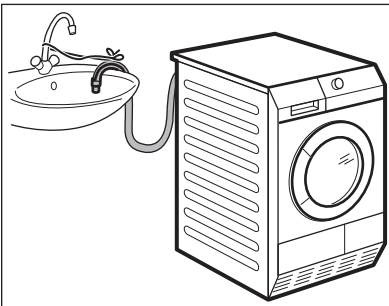

Product name: DK11.  
 Available from your authorized dealer  
 (can be attached to some types of the  
 tumble dryers)  
 Installation kit for through draining of the  
 condensed water into a basin, siphon,  
 gully, etc. After installation the water con-  
 tainer is drained automatically. The water  
 container must stay in the appliance.  
 Installed hose must be on the height from  
 minimum of 50 cm to maximum of 1 m  
 from floor level. The hose cannot be in  
 loop. If possible decrease the length of  
 the hose.

Read carefully the instructions supplied  
 with the kit.

### PEDESTAL WITH THE DRAWER

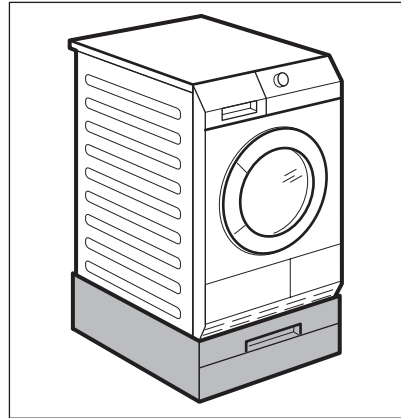

Product name: PDSTP10.  
 Available from your authorized dealer.  
 To put the appliance higher at the level  
 which helps to easy load and remove the  
 laundry .  
 The drawer can be use for laundry storage  
 e.g. : towels, cleaning products and more.  
 Read carefully the instructions supplied  
 with the accessory.

## CONTROL PANEL

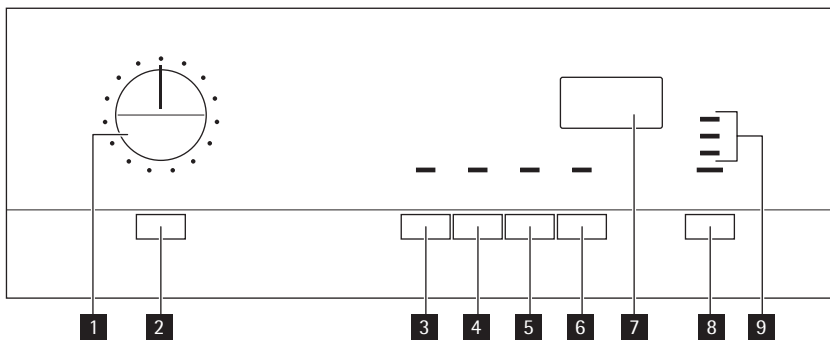

- 1 The programme dial
- 2 The On/Off push button
- 3 The Delicate push button
- 4 The Buzzer push button
- 5 The Anticrease push button
- 6 The Delay Start push button
- 7 The display
- 8 The Start/Pause push button
- 9 The indication lamps: *drain the water container, clean the filter, clean the condenser*



## BEFORE FIRST USE

Clean the tumble dryer drum with a moist cloth or set a short programme (e.g. 30

minutes time programme) with the load of moist cloths.

## PROGRAMMES

Pro-grammes	Load <sup>1)</sup>	Properties	Available functions	Fabric mark
Cottons				
Extra Dry	7 kg	To dry cotton pieces of clothing. Drying level: extra dry.	all	
Cupboard Dry <sup>2)</sup>	7 kg	To dry cotton pieces of clothing. Drying level: cupboard dry.	all	
Iron Dry <sup>2)</sup>	7 kg	To dry cotton pieces of clothing. Drying level: applicable to iron.	all	
Jeans	7 kg	To dry leisure clothing such as jeans, sweat-shirts of different material thicknesses (e.g. at the neck, cuffs and seams).	all	
Bed Linen	3 kg	To dry bed linen such as: single and double sheet, pillowcase, bed-spread.	all	
Duvets	3 kg	To dry single or double duvet and pillows (with feather, down or synthetic fillings).	all except Anticrease <sup>3)</sup>	
Delicates	3 kg	To dry delicate fabrics.	all <sup>3)</sup>	
Synthetics				
Extra Dry	3,5 kg	To dry thick or multi-layered fabrics, e. g. pullovers, bedding, table linen.	all	
Cupboard Dry <sup>2)</sup>	3,5 kg	To dry thin fabrics which are not ironed, e.g. easy care shirts, table linen, baby clothes, socks, lingerie with bones or wires.	all	
Iron Dry	3,5 kg	To dry thin fabrics which are also to be ironed, e.g. knitwear, shirts.	all	

Pro-grammes	Load <sup>1)</sup>	Properties	Available functions	Fabric mark
Easy Iron	1 kg (or 5 shirts)	To dry easy care fabrics such shirts and blouses; for minimum ironing effort. The results can be different for to the different types of fabric and its finish. Put fabrics in the tumble dryer straight. After the cycle, immediately remove dried fabrics and put on a cloths hanger.	all <sup>3)</sup>	
Sports	2 kg	To dry sportswear, thin fabrics, microfiber, polyester, which are not ironed.	all	
60 min.	3 kg	Time programme to dry individual items of laundry.	all	
30 min.	1 kg	Time programme to dry individual items of laundry.	all	

<sup>1)</sup> Maximal weight of dry clothes

<sup>2)</sup> For test institutes only:

To make a performance test use the standard programmes which are specified in the EN 61121 document.

<sup>3)</sup> Delicate activated by default

## USING THE APPLIANCE

### PREPARING THE LAUNDRY



Dry only the laundry applicable to dry in the tumble dryer. Make sure if the laundry is applicable to dry in the tumble dryer. Do the check of the fabric mark on the clothes.

Fabric mark	Property
	Applicable to dry in the tumble dryer
	Applicable to dry in the tumble dryer at standard temperature
	Applicable to dry in the tumble dryer at decreased temperature
	Not applicable to dry in the tumble dryer

Correctly prepare the laundry:

- close zips, button up duvet covers and attach loose ties or ribbons (e.g. ribbons of aprons) - laundry can tangle

- make sure the pockets are empty - remove metal items (paper clips, safety pins, etc.).
- turn items with 2 fabric layers inside out (e.g. cotton lined anoraks, the cotton fabric layer must be external).

Dry only:

- cotton and linen with Cottons programmes
- synthetic and mixtures with Synthetic programmes
- separately the strong coloured textiles and the light coloured textiles - colours can bleed
- cotton jersey and knitwear only with the applicable programmes - items can shrink



Do not put more laundry than the maximum load which is 7kg.

### LOADING THE LAUNDRY

1. Pull the appliance door
2. Load loosely the laundry.
3. Close the appliance door.

**CAUTION!**

Do not lock the laundry in between the appliance door and rubber seal.

## SWITCHING ON THE APPLIANCE

Push the On/Off button to activate or to deactivate the appliance. When the appliance is on, some indications come in to the view on the display.

## AUTO STAND-BY FUNCTION

To decrease the energy consumption, the automatic stand-by function deactivates the appliance:

- if the Start/Pause button was not pushed in the time of 5 minutes.
- after 5 minutes from the programme end.

Push the On/Off button to activate the appliance.

## SETTING A PROGRAMME

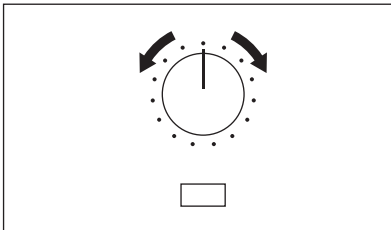

Use the programme dial to set the programme. The possible time to complete the programme come into view on the display.



The drying time you see is related to the load of 5 kg for cotton and jeans programmes. For the other programmes the drying time is related to the recommended loads. The drying time of the cotton and jeans programmes with the load more than 5 kg is longer.

## SPECIAL FUNCTIONS

Together with the programme you can set 1 or more special functions.

To activate or deactivate the function push the applicable push button.

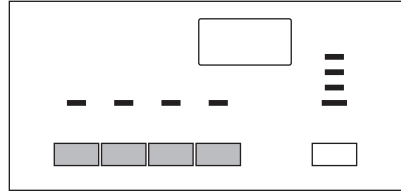

When the function is activated the LED above the push button comes into the view.

## THE DELICATE FUNCTION

To dry more lightly the sensitive and temperature sensitive textiles (e.g. acrylic, viscose). For fabrics with the symbol  on the fabric label. Programme operates with decreased heat.

## THE BUZZER FUNCTION

When the buzzer function is activated you can hear the buzzer at the:

- cycle end
- anti-crease phase start and end
- cycle interruption

The buzzer function is by default always on. You can use this function to activate or deactivate the sound.

## THE ANTICREASE FUNCTION

Extends anticrease phase (30 minutes) at the end of the drying cycle to 90 minutes. This function prevents laundry from creases. Laundry can be removed during the anticrease phase.

## THE DELAY START FUNCTION



Let to delay the start of a drying programme from minimum of 30 minutes to maximum of 20 hours.

1. Set the drying programme and functions.
2. Push the Delay start button again and again until the necessary time of the delay come into the view on the display (e.g. 12h if the programme has to start after 12 hours.)
3. To activate the Delay start function, push the Start/Pause button. The time to start decreases on the display.

## STARTING A PROGRAMME

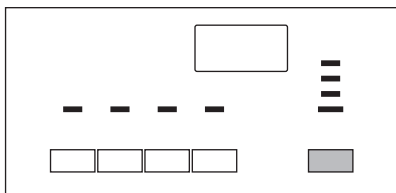

To activate the programme push the Start/Pause button. The LED above the push button changes the color to red.

- clean the filter
- drain the water container  
(See chapter *CARE AND CLEANING*.)

## CHANGE A PROGRAMME

To change a programme, turn the programme selector to **Stop** and then set the programme again.

## CHILD LOCK FUNCTION

The child lock can be set to prevent the children to play with the appliance. The child lock function locks all push buttons and the programme dial (this function does not lock On/Off button). To activate the child lock function push the Anti-increase and Delay Start buttons at the same time until the symbol  come into view on the display. To deactivate push again the above buttons until the symbol go out of view.

You can activate the child lock function:

- before you push the Start/Pause button - the appliance cannot start
- after you push the Start/Pause button - all the push buttons and the programme dial are deactivated

## AT THE END OF PROGRAMME

When the drying cycle is completed, the  symbol flashes on the display. If the Buzzer function is on, an acoustic signal sounds intermittently for one minute.

To remove the laundry:

1. Push the On/Off button for 2 seconds to deactivate the appliance.
2. Open the appliance door.
3. Remove the laundry.
4. Close the appliance door.



After each drying cycle:

## HINTS AND TIPS



### ECOLOGICAL HINTS

- Do not use fabric softener to wash and then dry. In the tumble dryer laundry becomes soft automatically.
- Use the condensate as distilled water, e.g. for steam ironing. If necessary clean the condensate before (e.g. with a coffee filter) to remove possible small pieces of fluff.
- Always keep the airflow slots on the bottom of the appliance clear.
- Use the load volumes specified in the programmes chapter.
- Make sure that is good airflow in the appliance installation position.
- Clean the filter after each drying cycle.
- Spin good the laundry before drying.

### WATER HARDNESS AND CONDUCTIVITY



Water hardness can be different for different locations. Water hardness has an effect on the water conductivity and the operation of the conductivity sensor in the appliance. If you know the value of the water conductivity you can adjust the sensor to dry with the better results.

To change the sensor conductivity:

1. Turn the programme dial to available programme.
2. Push at the same time the Delicate and Antcrease buttons and hold down until one of the these symbols go into view on the display:
  -  low conductivity <300 µS/cm
  -  moderate conductivity 300-600 µS/cm
  -  high conductivity >600 µS/cm
3. Push the Start Pause button again and again until you set necessary level.
4. To memorise setting push at the same time the Delicate and Antcrease buttons.

### WATER CONTAINER FULL — INDICATION

By default the indication LED is always on. It comes into the view at the end of the cycle or when the water container is full. When you use an external equipment to drain the container, the LED can be off. To activate or deactivate the indication:

1. Turn the programme dial to available programme.
2. Push at the same time the Delicate and Delay Start buttons and hold down until you see the correct setting:
  - the LED is off and the symbol  goes into the view - The LED is permanently off
  - the LED is on and the symbol  goes into the view - The LED is activated

## CARE AND CLEANING

### CLEANING THE FILTER

At the end of each cycle the *filter* LED is on to tell you that the filter must be cleaned.



The filter collects the fluff. The fluff occurs while the cloths are dried in the tumble dryer.

To clean the filter:

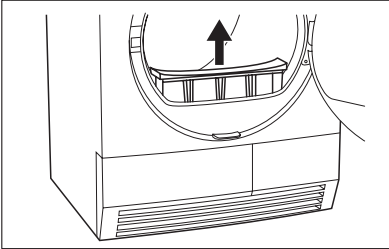

1. Open the door.
2. Pull the filter.

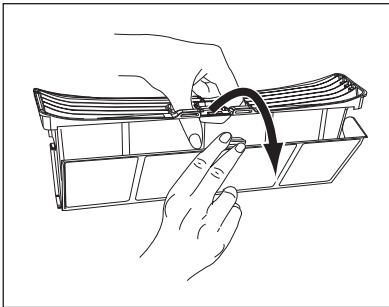

3. Open the filter.

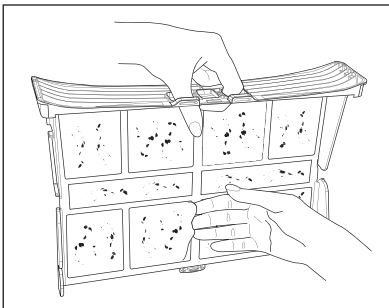

4. Use a moist hand to clean the filter.

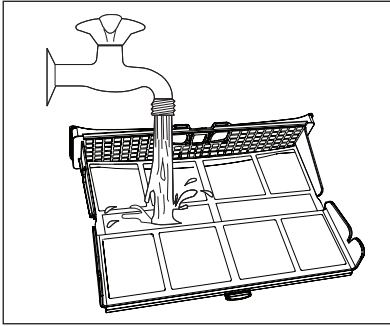

5. If necessary clean the filter with warm water using a brush.  
Close the filter.

6. Remove fluff from the filter socket.  
For this a vacuum cleaner can be used.
7. Put the filter inside the filter socket.

**CAUTION!**

Do not operate the tumble dryer without the filter or with damaged or blocked filter.



Clean the filter after each drying cycle. Clogged filter increases the cycle time and causes higher energy consumption.

If the condensed water container is full, the programme breaks off automatically and the *drain the condensed water container* LED is on. To continue the programme, drain the condensed water container and press the start button.



To drain the condensed water container automatically you can install draining accessory (see chapter: *ACCESSORIES*)

## DRAINING THE CONDENSED WATER CONTAINER

Drain the condensed water container after each drying cycle.

To drain the condensed water container:

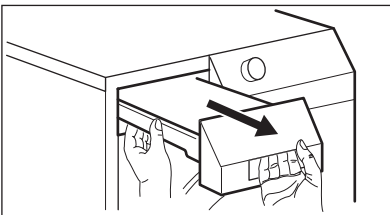

1. Pull the condensed water container and keep it in horizontal position.

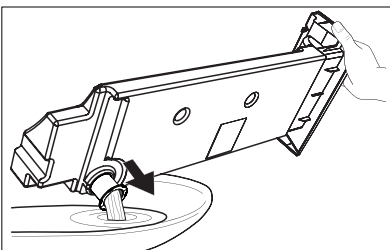

2. Move the plastic connection out and drain the condensed water container into a sink or equivalent receptacle.



**WARNING!**

Risk of poisoning. The condensed water is not applicable to drink or to prepare food.



The condensed water can be used as distilled water, e.g. for steam ironing. If necessary filter the condensed water (e.g. with a coffee filter) to remove possible residue and small pieces of fluff.

3. Move plastic connection in and install water container.

---

## CLEANING THE CONDENSER

If the *condenser* LED is on, the condenser must be cleaned.

---

To clean the condenser:

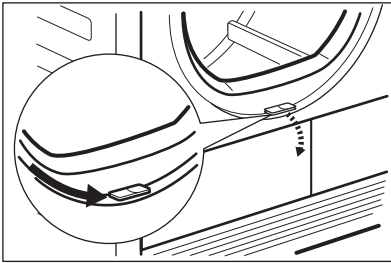

1. Open the loading door.
2. Move the release button on the bottom of the door opening and open the condenser door.

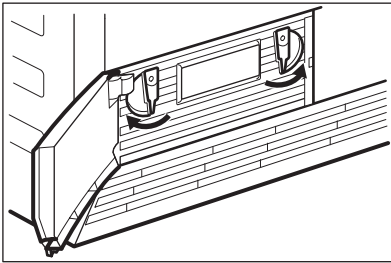

3. Turn the 2 blockages to unlock the condenser lid.

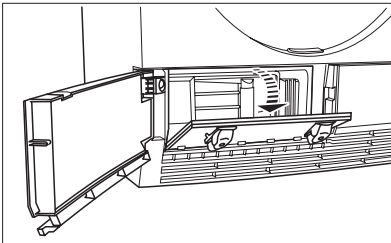

4. Lower the condenser lid.



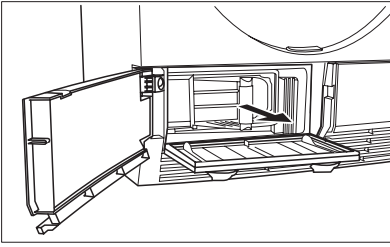

5. Catch the handle and pull the condenser out from the bottom compartment. Move condenser horizontally to do not spill remaining water.

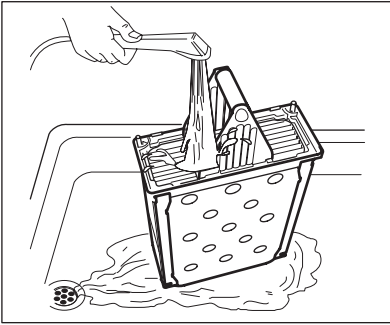

6. Clean the condenser in vertical position over a basin or paddling. Rinse through with a hand shower.

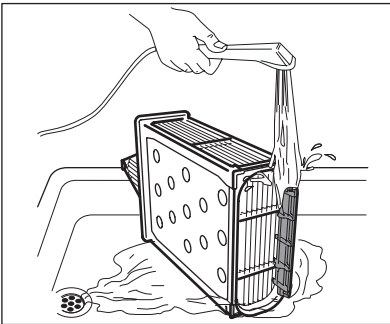

7. Clean the condenser filter. Rinse through with a hand shower.

8. Put the condenser back inside the bottom compartment.
9. Close the condenser lid.
10. Lock the 2 blockages until they snap.
11. Close the condenser door.



### CAUTION!

Do not operate the tumble dryer when the condenser is blocked with fluff. This could cause the damage to the tumble dryer. This also increases energy consumption.

Do not use sharp objects to clean the condenser. The damaged condenser could cause leaks.

Do not operate the tumble dryer without the condenser.

### CLEANING THE DRUM



#### WARNING!

Disconnect the appliance before you clean it.

Use a standard neutral soap detergent to clean the inner surface of the drum and drum ribs. Dry the cleaned surfaces with a soft cloth.



**CAUTION!**

Do not use abrasive materials or steel wool to clean the drum.

## **CLEANING THE CONTROL PANEL AND HOUSING**

Use a standard neutral soap detergent to clean the control panel and housing.

Use a moist cloth to clean. Dry the cleaned surfaces with a soft cloth.



**CAUTION!**

Do not use furniture cleaning agents or cleaning agents which can cause corrosion to clean the appliance.

## TROUBLESHOOTING

## TROUBLESHOOTING

Problem <sup>1)</sup>	Possible cause	Remedy
The tumble dryer does not operate.	The tumble dryer is not connected to mains supply.	Connect in at mains socket. Check fuse in fuse box (domestic installation).
	The loading door is opened.	Close the loading door.
	The On/Off button was not pushed.	Push the On/Off button.
	The Start/Pause button was not pushed.	Push the Start/Pause button.
	The appliance is in the standby mode.	Push the On/Off button.
Unsatisfactory drying results.	Incorrect programme selection.	Do the selection of the applicable programme. <sup>2)</sup>
	The filter is clogged.	Clean the filter. <sup>3)</sup>
	The condenser is clogged.	Clean the condenser. <sup>3)</sup>
	Too high volume of the load.	Obey the maximum load volume.
	The airflow grill is clogged.	Clean the airflow grill in the bottom of the appliance.
	Dirt on the inner surface of the drum.	Clean the inner surface of the drum.
	Too high water hardness.	Set applicable water hardness <sup>4)</sup> .
The door does not close.	The filter not locked in the position.	Put the filter in the correct position.
	The laundry is locked between the door and the seal.	Put the load correctly in the drum.
<b>Err</b> (Error) on the display.	You try to change the programme or the function after the start of the cycle.	Turn the tumble dryer off and on. Make the new selection.
	The function you try to activate is not applicable with the selected programme.	Turn the tumble dryer off and on. Make the new selection.
Abnormally elapsing time on the display.)	The time to end is calculated on the basis of the volume and dampness of the laundry.	The automatic procedure — this is not the appliance malfunction.
Programme inactive.	The water container is full.	Drain the water container <sup>3)</sup> , push the Start/Pause button.

Drying cycle too short.	To small laundry volume.	Do the selection of time programme.
	The laundry is too much dried.	Do the selection of time programme or higher drying level (e.g. Extra Dry)
Drying cycle too long <sup>5)</sup>	The filter is clogged.	Clean the filter.
	Too high volume of the load.	Obey the maximum load volume.
	The laundry not spun sufficiently.	Spin correctly the laundry.
	Very high room temperature - this is not the appliance malfunction.	If possible, lower the room temperature.

- 1) If there is an error message on the display (e.g. **E51**): Turn the tumble dryer off and on. Make a selection of the new programme. Push the Start/Pause button. Does not operate? - contact the service centre and give the error code.
- 2) follow the programme description — see *PROGRAMMES* chapter
- 3) see *CARE AND CLEANING* chapter
- 4) see section *WATER HARDNESS* in *HINTS AND TIPS* chapter
- 5) Note: After maximum 5 hours the drying cycle ends automatically (see *Drying cycle complete* section).

# TECHNICAL INFORMATION



height x width x depth	850 x 600 x 600 mm (maximal 640 mm)
drum volume	118 l
maximum depth with the load door opened	1090 mm
maximum width with the load door opened	950 mm
adjustable height	850 mm (+ 15 mm - feet regulation)
the appliance weight	41 kg
maximum load volume	<b>7</b> kg
voltage	230-240 V
frequency	50 Hz
necessary fuse	13 A
total power	2800 W
energy efficiency class	<b>B</b>
energy consumption kWh/cycle <sup>1)</sup>	<b>3,92</b> kWh
annual energy consumption <sup>2)</sup>	284,1 kWh
type of use	Domestic
permitted ambient temperature	+ 5°C to + 35°C

**1)** 7 kg of cotton, centrifuged at 1000 rpm with reference to EN 61121

**2)** The sum of approximate energy consumption to dry:  
 150 kg of the cotton laundry with *cupboard dry* programme  
 + 280 kg with *iron dry* programme  
 + 150 kg of synthetic laundry with *cupboard dry* programme.  
 This is approximate consumption for the 4 person household which correctly use the tumble dryer.

# INSTALLATION

## APPLIANCE POSITIONING

- The tumble dryer must be installed in a clean position, where dirt does not collect.
- Air must flow freely around the appliance. Make sure that the front airflow slots in the bottom of the appliance are not blocked.
- To keep vibration and noise at the minimum, when the tumble dryer operates, it must be put on a stable and flat surface.
- When the appliance is put in its permanent position, check if is fully level with the aid of a spirit level. If it is not, adjust the feet until it is.
- Do not remove the feet. Do not decrease the floor clearance through thick carpets, bar of wood or equivalent. This can increase the heat which can cause interference with the operation of the appliance.



- The temperature of the hot air which occurs in the tumble dryer can increase to 60 °C. The appliance must not be installed on the floor which is not resistant to high temperatures.
- When the tumble dryer operates, the room temperature must not be lower than +5 °C and higher than +35 °C. This can cause unwanted effect on the performance of the appliance.
- If it is necessary to move the appliance, it must be moved vertically.
- The appliance must not be installed behind a lockable door, a sliding door, a door with a hinge on the opposite side to that of the appliance in such a way that a full opening of the tumble dryer is restricted.

It is possible to adjust the height of the tumble dryer. To do that adjust the feet (see picture).

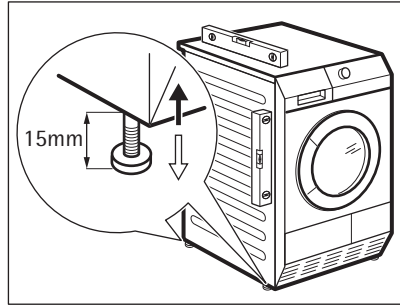

## UNPACKING



### CAUTION!

Before use all parts of the transport packaging must be removed.

To remove the polystyrene blockages:

1. Open the load door.
2. Pull plastic hose with the polystyrene blockages out from the drum.

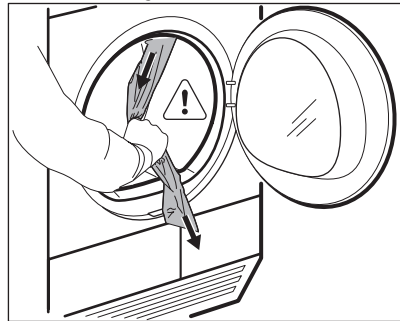

## INSTALLATION UNDER A COUNTER

The appliance can be installed as free-standing or below the kitchen counter with correct space (see picture).

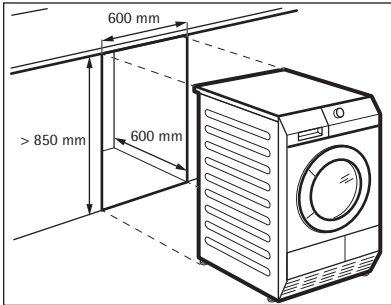

## THE LOAD DOOR REVERSAL

The load door can be installed by the user in the opposite side. It can help to easily put and remove the laundry or if there is a limit to install the appliance. (see separate leaflet).

## ELECTRICAL CONNECTION

- Connect the appliance to a grounded socket. Refer to the applicable electrical requirements.
- Make sure that the electrical data on the rating plate agrees with the power supply.
- Always use a correctly installed shock-proof socket.
- Do not use multiple plugs and extension cables. There is a risk of fire.
- All replacements of power supply cable must be carried out by our Service.
- Make sure not to squash or cause damage to the mains plug and cable behind the appliance.
- Do not pull the mains cable to disconnect the appliance. Always pull the mains plug.
- The plug must be dry.

The data about mains voltage, type of current and the necessary fuse are on the rating plate and in the "TECHNICAL INFORMATION" chapter. The rating plate is behind the load door (see the "PRODUCT DESCRIPTION" chapter).

The appliance has a power supply cable with plug fitted with 13 A fuse. If necessary, replace the fuse in the plug by 13 A ASTA BS 1363/A approved fuse.

The wires in the power supply cable are coloured as follow:

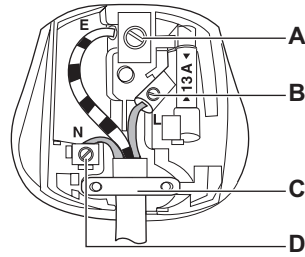

**A)** green and yellow - ground — earth (E)

**B)** brown - live (L)

**C)** cord clamp

**D)** blue - neutral (N)

The green and yellow coloured wire must be connected to the terminal with **E** mark or the ground  $\perp$  mark or the green and yellow coloured terminal.

The blue coloured wire must be connected to the terminal **N** or black coloured .

The brown coloured wire must be connected to the terminal **L** or red coloured .

The wires of the cable must be no cut or stray strands of wire present and the cable clamp must be secure over the outer sheath.

## Permanent connection

The necessary condition of permanent connection is to install a double-pole isolating switch directly on the supply terminals.

The type of switch must be correct for the necessary load and must align with applicable electrical requirements.

The switch must not break the yellow and green coloured ground wire.

[www.aeg.com/shop](http://www.aeg.com/shop)

136917420-B-292011

